

2JMAS01

(DATASHEET)

Type	Multiband antenna
Frequencies	AMPS (824-894 MHz) ISM (868 MHz) GSM (900 MHz) DCS (1800 MHz) PCS (1900 MHz) 3G (UMTS 2.1 GHz) WIFI / BLUETOOTH (2.4 GHz)
Mounting	Embedded Patch Mount
Revision	00



P. Tipul



D. Noble

1. SPECIFICATION

1.1. Electrical Specifications

Frequencies	AMPS (824-894 MHz) ISM (868 MHz) GSM (900 MHz) DCS (1800 MHz) PCS (1900 MHz) 3G (UMTS 2.1 GHz) WIFI / BLUETOOTH (2.4 GHz)
Impedance	50 Ohms
Polarization	Linear
Gain	0dBi
VSWR	<2.5:1
Power handling	25W
Operating temperature	-40°C to +85°C

1.2. Connection Specifications

Connector type: U.FL
 Cable: Microcoax 1.13
 Cable length: 10 cm

For different cable length and connector type ask our sales team.

1.3. Mechanical Specifications and Dimensions

Material: FR4
 Max. dimensions: 16mm x 42mm x 1.6mm (H x L x T)
 Weight: 2.6 g 'weight counted with cable above'

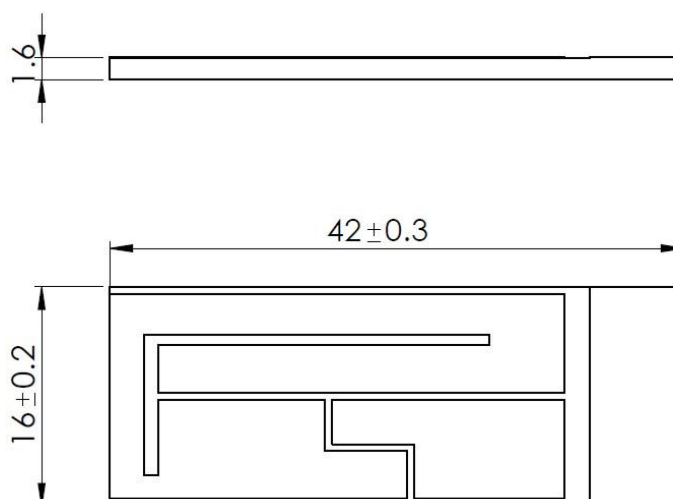

2. MEASUREMENT

824MHz
Freq = 0.8200GHz Az= 45 EL= -45

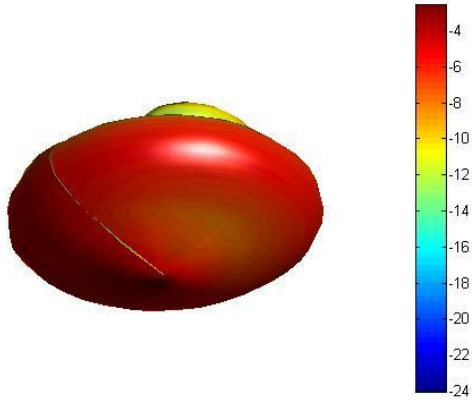

868MHz
Freq = 0.8700GHz Az= 45 EL= -45

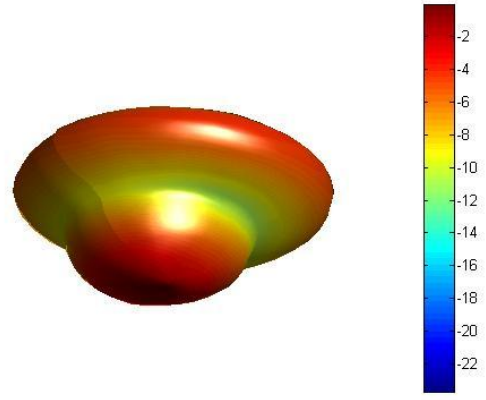

900MHz
Freq = 0.9GHz Az= 45 EL= -45

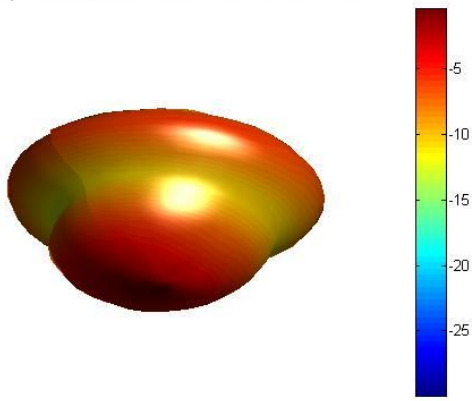

1800MHz
Freq = 1.8GHz Az= 45 EL= -45

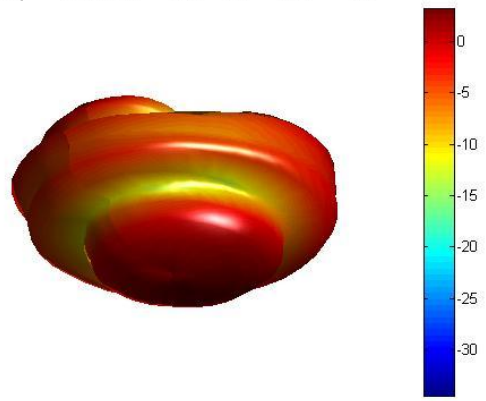

1900MHz
Freq = 1.9GHz Az= 45 EL= -45

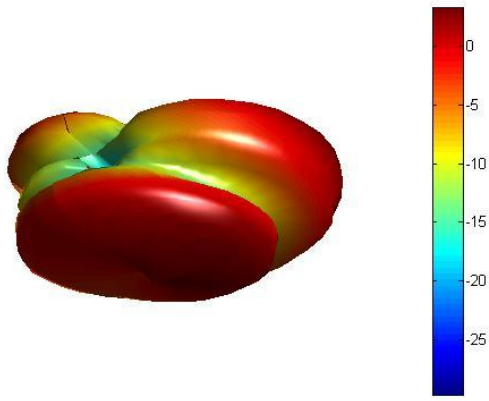

2100MHz
Freq = 2.1GHz Az= 45 EL= -45

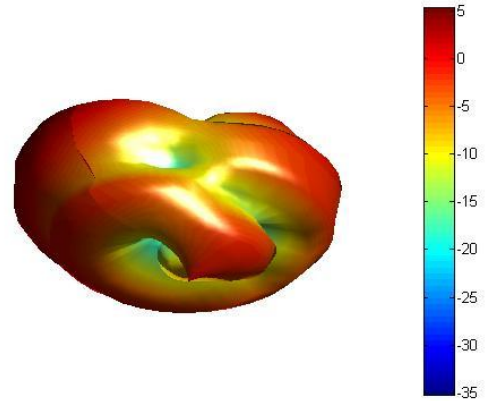

VSWR without housing

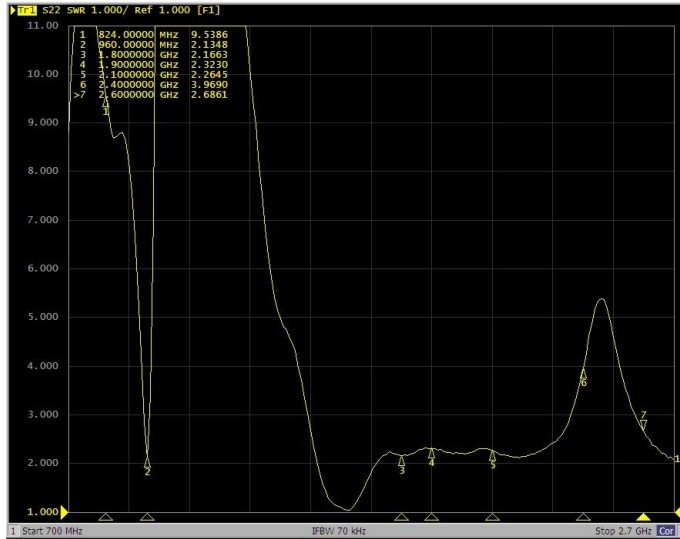

Log Mag without housing

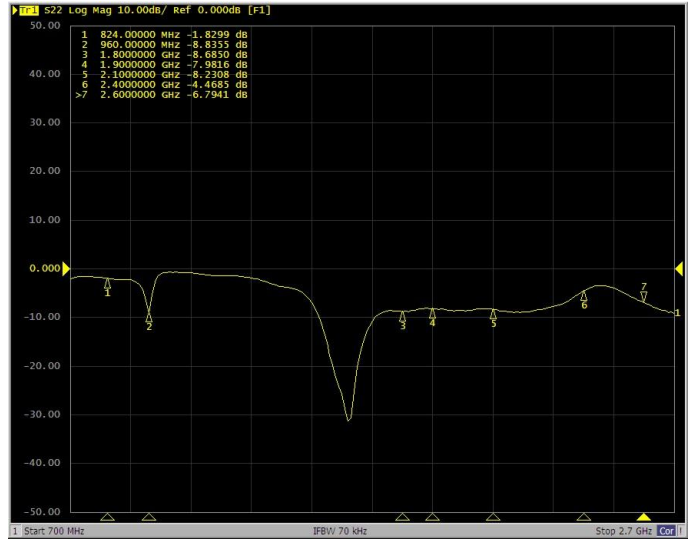

VSWR with housing

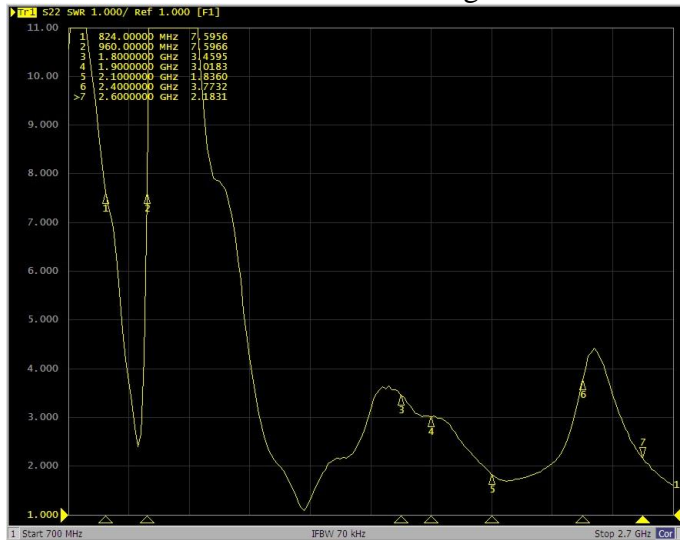

Log Mag with housing

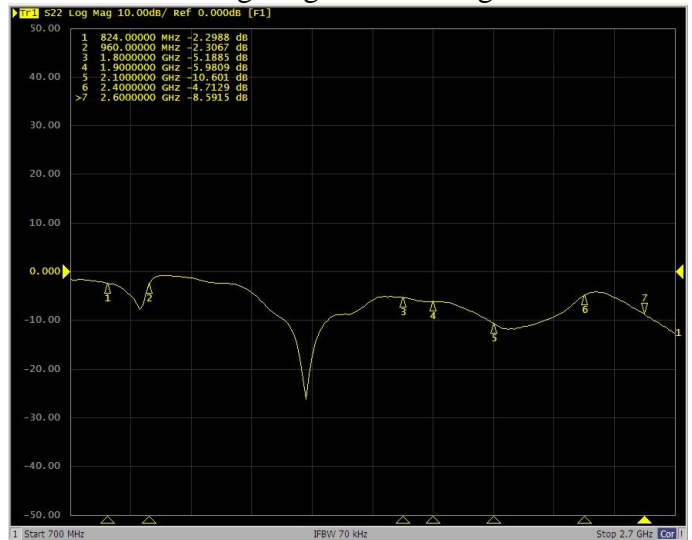

Tested inside housing 2J630, with 10cm cable length.

Tested inside housing 2J630, with 10cm cable length.

3. IMAGES

